

MOTOR DRIVER FOR VTR

The KA8301 is a monolithic integrated circuit designed to perform bi-directional DC motor driving, braking and speed control for VCRs. The speed control can be achieved by adjusting the external voltage of the motor speed control pin.

FEATURES

- Stable braking characteristics by built-in braking function.
- Built-in element to absorb dash current derived from changing motor direction and braking motor driving.
- Built-in external motor speed control pin.
- Stable driving direction change.
- CMOS logic level compatible input level.

APPLICATION

- VCR
- CDP
- TOY

BLOCK DIAGRAM

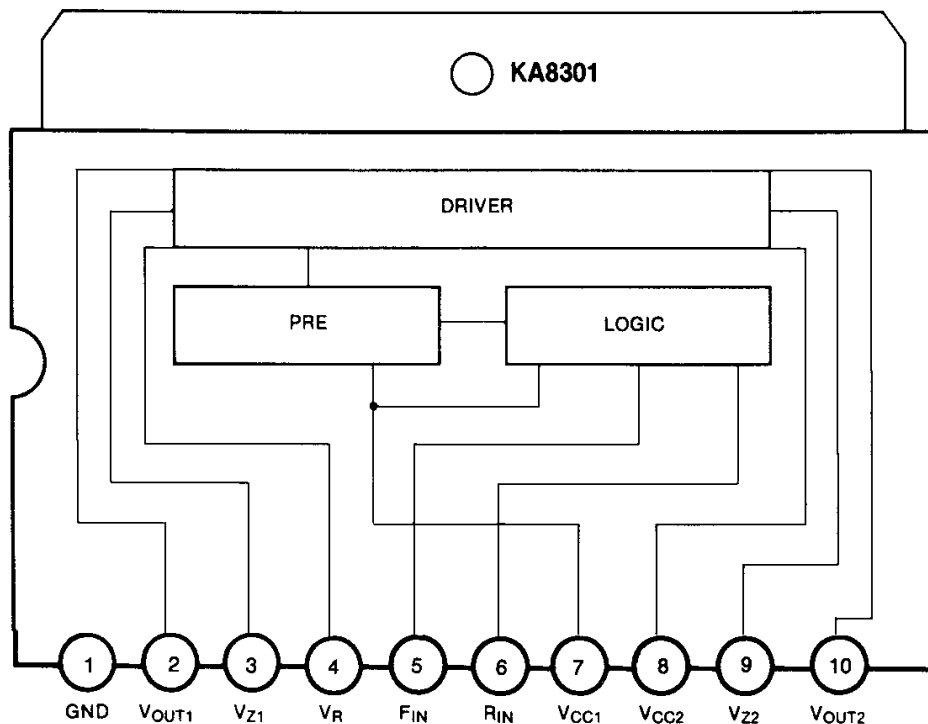
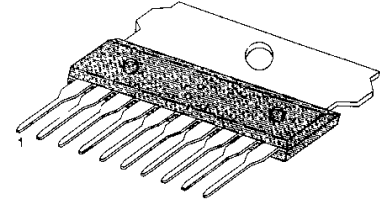

Fig. 1

10 SIP H/S



ORDERING INFORMATION

Device	Package	Operating Temperature
KA8301	10 SIP H/S	- 25 ~ + 75°C

ABSOLUTE MAXIMUM RATINGS (Ta = 25°C)

Characteristics	Symbol	Value	Unit
Supply Voltage	V_{CC}	18	V
Allowable Power Dissipation	P_D	2.2	W
Operating Temperature	T_{OPR}	-25 ~ +75	°C
Storage Temperature	T_{STG}	-55 ~ +125	°C
Output Current	I_{OUT}	1.6*	A
Input Voltage	V_{IN}	-0.3 ~ V_{CC}	V

* Duty 1/100, pulse width 500 μ s**RECOMMENDED OPERATING CONDITIONS (Ta = 25°C)**

Characteristics	Symbol	Min	Typ	Max	Unit
Supply Voltage	V_{CC}	8	12	16	V

ELECTRICAL CHARACTERISTICS (V_{CC} = 12V, Ta = 25°C)

Characteristics	Symbol	Min	Typ	Max	Unit	Condition
Quiescent Current	I_{CCQ}	3	5.5	10	mA	Pin 5, 6: GND, $R_L = \infty$
Minimum Input on Current 1	I_{IN1}	—	10	50	μ A	$R_L = \infty$, Pin 5: I_{IN1} , Pin 6: L
Minimum Input on Current 2	I_{IN2}	—	10	50	μ A	$R_L = \infty$, Pin 5: L, Pin 6: I_{IN2}
Input Threshold Voltage 1	V_{INTH1}	0.7	1.3	2.0	V	$R_L = \infty$, Pin 5: V_{INTH1} , Pin 6: L
Input Threshold Voltage 2	V_{INTH2}	0.7	1.3	2.0	V	$R_L = \infty$, Pin 5: L, Pin 6: V_{INTH2}
Output Leakage Current 1	I_{OL1}	—	—	1	mA	$R_L = \infty$, Pin 5, 6: GND
Output Leakage Current 2	I_{OL2}	—	—	1	mA	$R_L = \infty$, Pin 5, 6: GND
Zener Current 1	I_{Z1}	—	0.85	1.5	mA	Pin 5: H, Pin 6: L, $R_L = \infty$
Zener Current 2	I_{Z2}	—	0.85	1.5	mA	Pin 5: L, Pin 6: H, $R_L = \infty$
Output Voltage 1	V_{O1}	6.6	7.2		V	Pin 5: H, Pin 6: L, $R_L = 60\text{ohm}$
Output Voltage 2	V_{O2}	6.6	7.1		V	Pin 5: L, Pin 6: H, $R_L = 60\text{ohm}$
Saturation Voltage Pin 10-1	V_{CE10-1}	—	0.83	1.5	V	$I_{SINK} = 100\text{mA}$ Pin 5: H, Pin 6: L, $R_L, R_C = \infty$
Saturation Voltage Pin 2-1	V_{CE2-1}	—	0.83	1.5	V	$I_{SINK} = 100\text{mA}$ Pin 5: L, Pin 6: H, $R_L, R_C = \infty$
Saturation Voltage Pin 8-2	V_{CE8-2}	—	0.83	1.5	V	$I_{SOURCE} = 100\text{mA}$ Pin 5: H, Pin 6: L, $R_L, R_C = \infty$
Saturation Voltage Pin 8-10	V_{CE8-10}	—	0.83	1.5	V	$I_{SOURCE} = 100\text{mA}$ Pin 5: L, Pin 6: H, $R_L, R_C = \infty$

TEST CIRCUIT

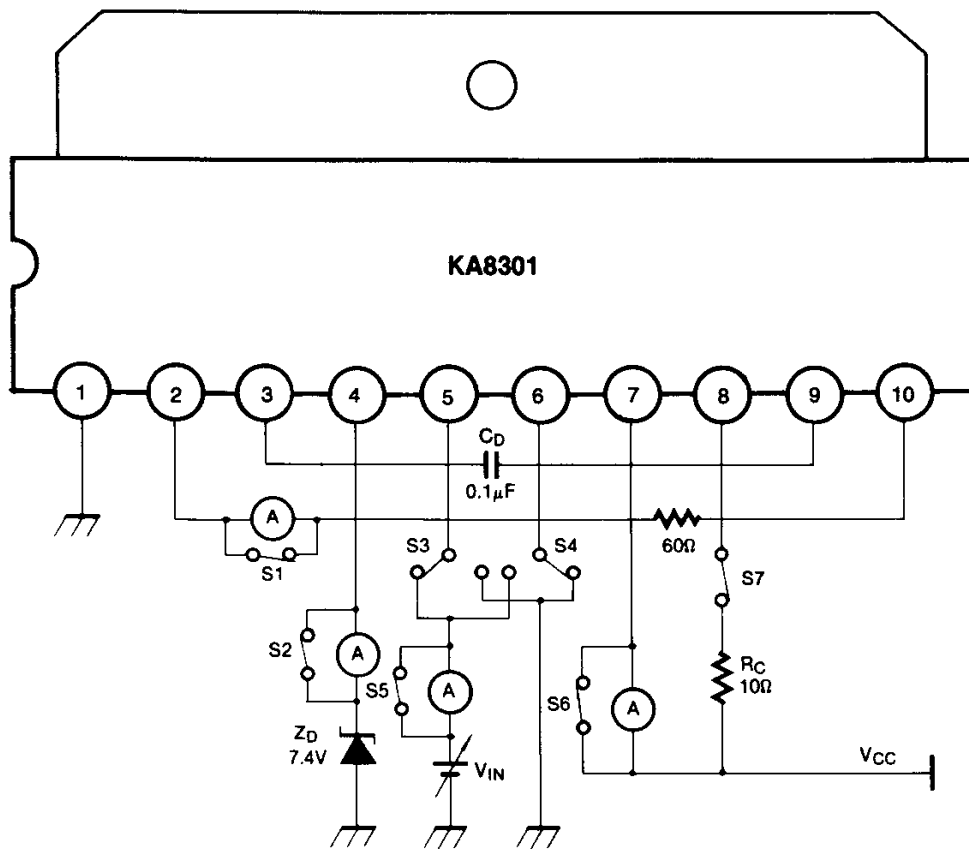

Fig. 2

LOGIC TRUTH TABLE

F_{IN} (Pin 5)	R_{IN} (Pin 6)	V_{O1} (Pin 2)	V_{O2} (Pin 10)	Note
L	L	L	L	Braking
L	H	L	H	Reverse
H	L	H	L	Forward
H	H	L	L	Braking

* Input Level 'H' > 2.0V

Input Level 'L' < 0.7V

APPLICATION INFORMATION

– FORWARD & REVERSE CONTROL LOGIC

If F_{IN} (5 pin) & R_{IN} (6 pin) = 'L', load current (I_L) flows from V_{OUT1} (2 pin) to V_{OUT2} (10 pin).

If F_{IN} = 'L' & R_{IN} = 'H', load current (I_L) flows from V_{OUT2} to V_{OUT1} .

– FORCED STOP LOGIC

If F_{IN} & R_{IN} = 'H' or 'L'. The device stops supplying power to motor while absorbing counter electromotive force from the motor as a brake.

– RUSH CURRENT ABSORBING CIRCUIT

If a high voltage generated during reversing operation is applied across V_{OUT1} & V_{OUT2} , an internal comparator activates the rush current absorbing circuit.

– DRIVING STAGE

In the forward mode, the driving stage supplies a load current to the motor from 2 pin to 10 pin. In the reverse mode. It supplies the current from 10 pin to 2 pin.

The output voltage V_{OUT} applied to the motor is given by the following method:

$V_{OUT(V)} = V_{ZD} - V_{CE(SAT)}$ V_{ZD} ; Zener Voltage applied to 4 pin.

If 4 pin is left open, the output voltage is given by the following method:

$V_{OUT(V)} = V_{CCI} - V_{CE(SAT PNP)} - 2V_F - V_{CE(SAT)}$

POWER REDUCTION CURVE

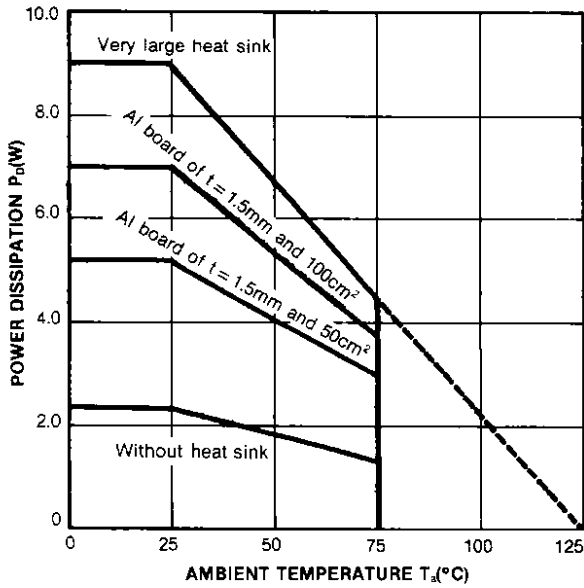

QUIESCENT CURRENT VS. SUPPLY VOLTAGE

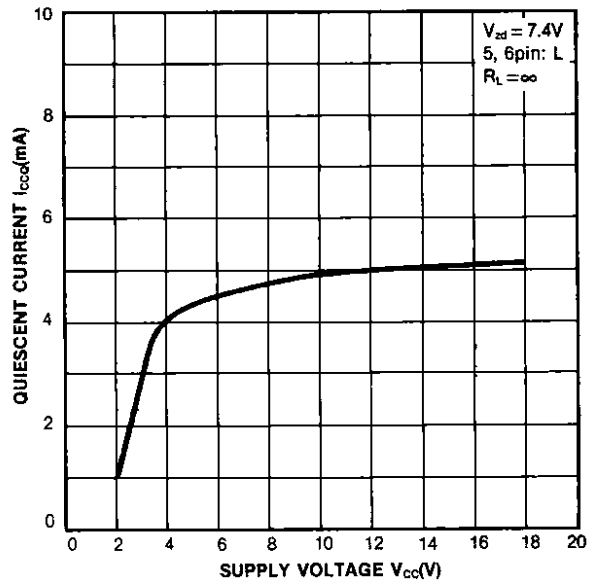

MAXIMUM OUTPUT VOLTAGE VS. SUPPLY VOLTAGE

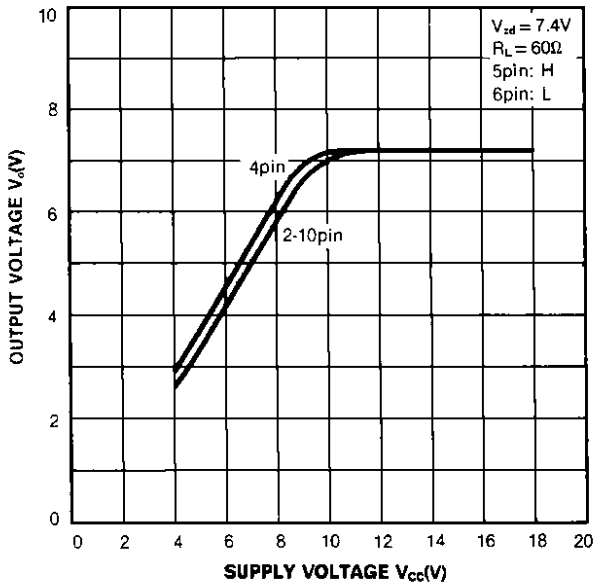

MAXIMUM OUTPUT VOLTAGE VS. SUPPLY VOLTAGE

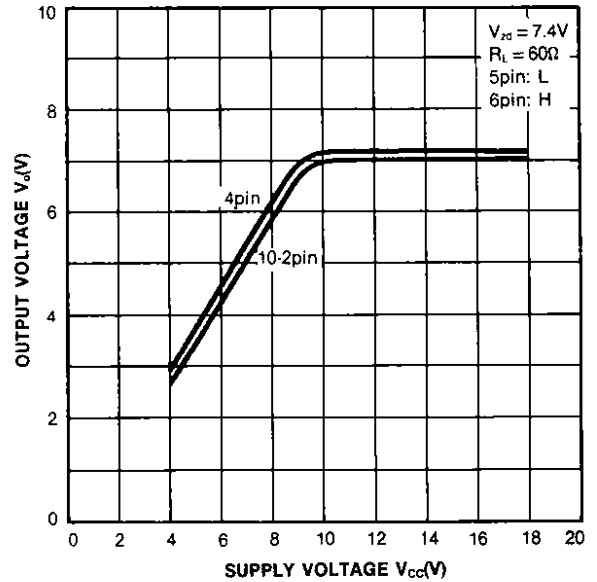

QUIESCENT CURRENT VS. AMBIENT TEMPERATURE

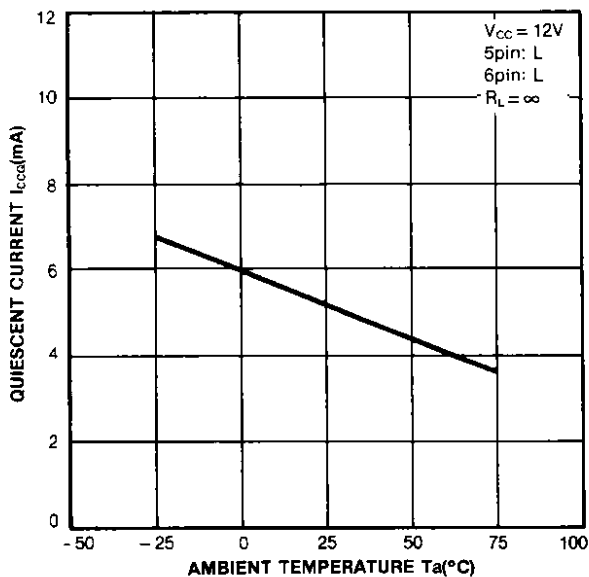

OUTPUT VOLTAGE VS. AMBIENT TEMPERATURE

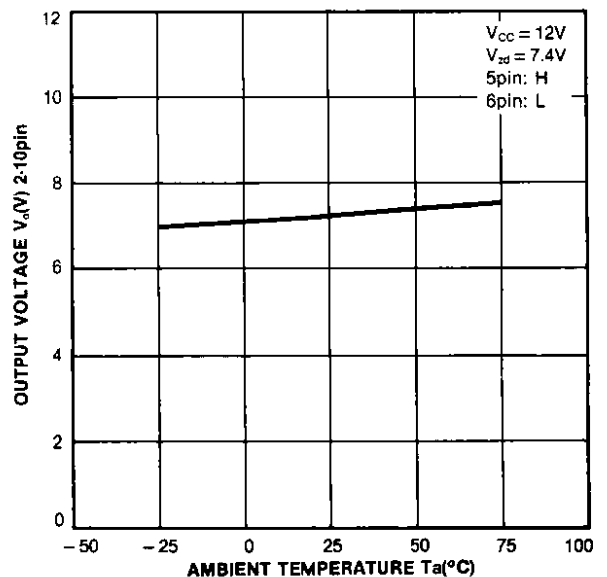

OUTPUT VOLTAGE VS. AMBIENT TEMPERATURE

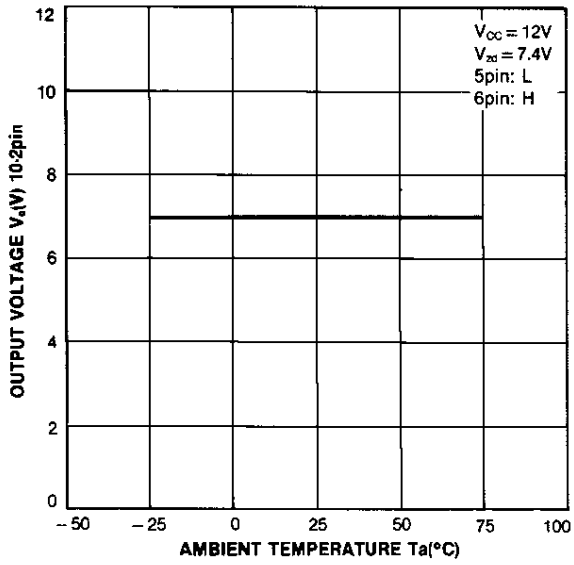

OUTPUT SATURATION VOLTAGE VS. SINK CURRENT

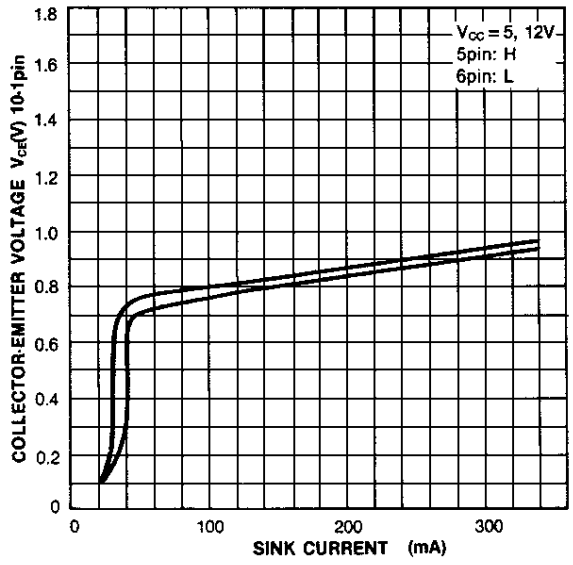

OUTPUT SATURATION VOLTAGE VS. SINK CURRENT

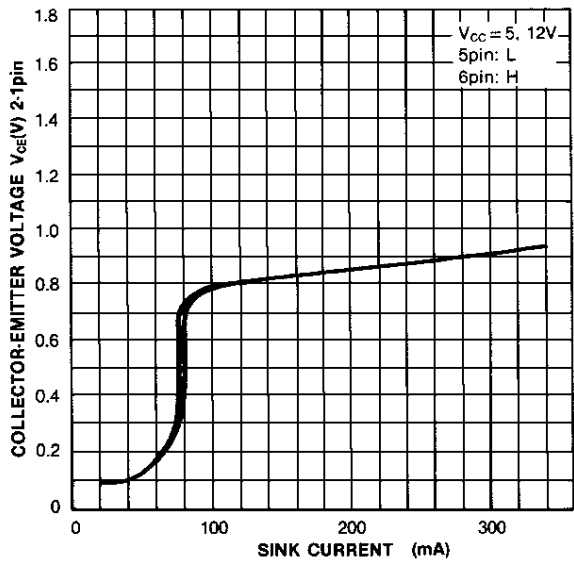

OUTPUT SATURATION VOLTAGE VS. SOURCE CURRENT

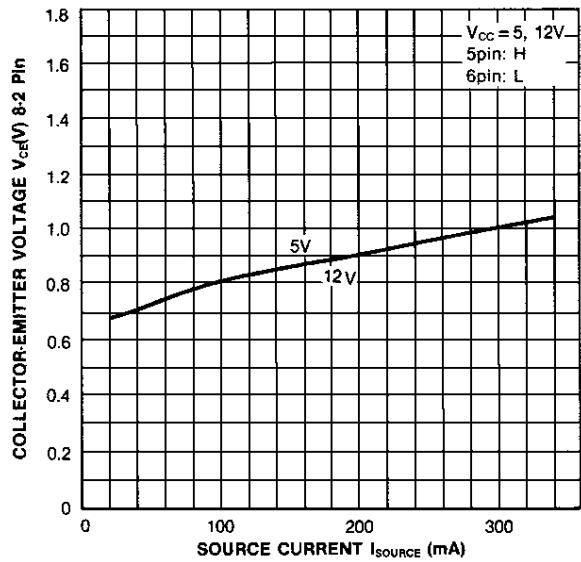

OUTPUT SATURATION VOLTAGE VS. SOURCE CURRENT

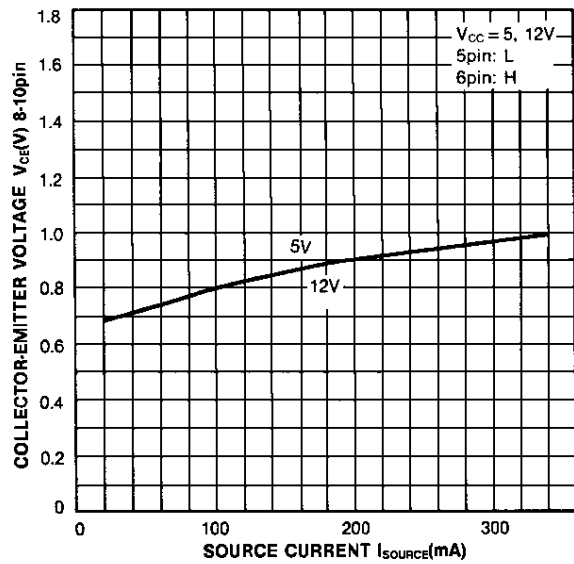

OUTPUT VOLTAGE VS. REFERENCE VOLTAGE

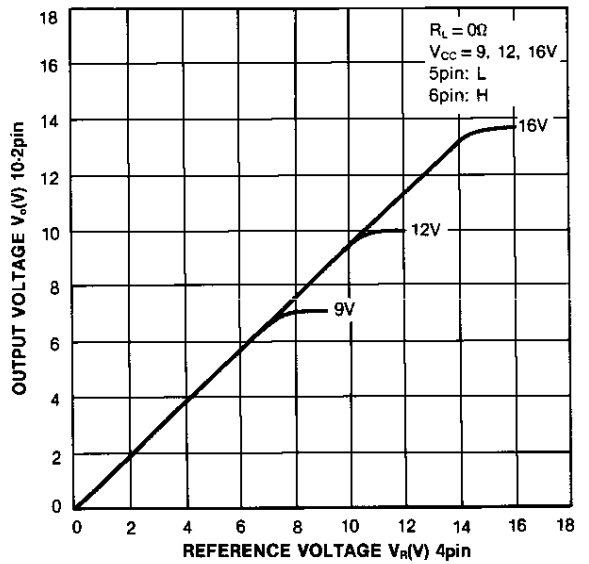

OUTPUT VOLTAGE VS. REFERENCE VOLTAGE

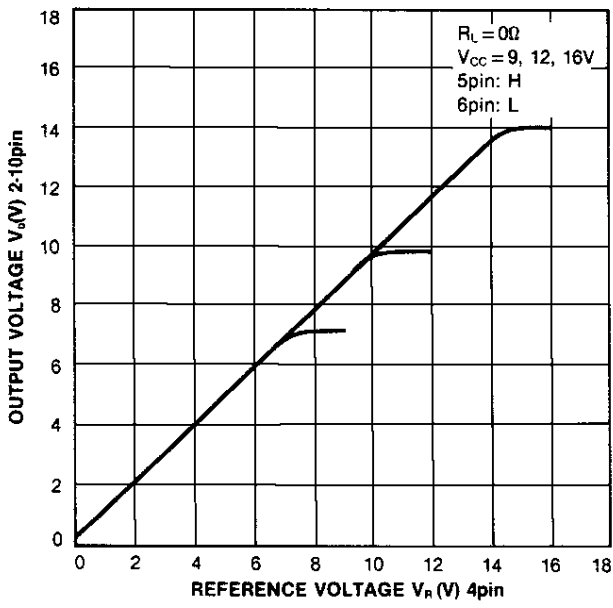

ZENER CURRENT VS. OUTPUT CURRENT

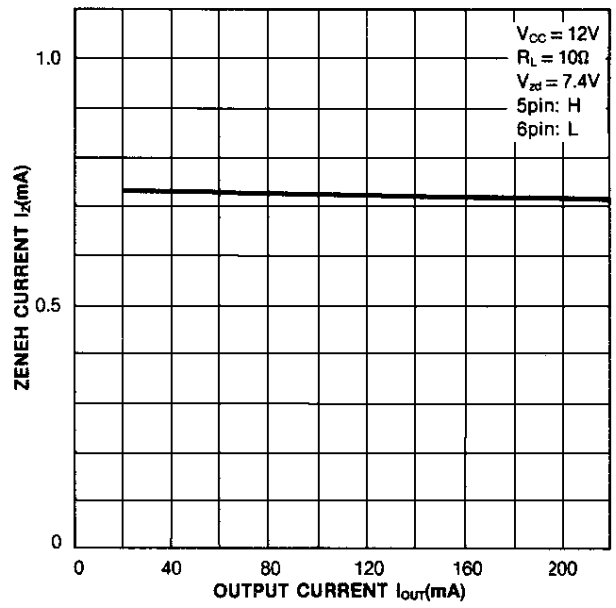

OUTPUT VOLTAGE VS. OUTPUT CURRENT

