



General Description

The AZV321 is single low voltage (2.7-5.5V) op amp which has rail-to-rail output swing capability. The input common-mode voltage range includes ground. The chip exhibits excellent speed-power ratio, achieving 1MHz of bandwidth and 1V/ μ s of slew rate with low supply current.

The AZV321 is built with BiCMOS process. It has bipolar input and output stages for improved noise performance, low input offset and higher output current drive.

AZV321 is available in the package of SC70-5, which is approximately half the size of SOT-23-5. The small package saves space on pc boards, and enables the design of small portable electronic devices. It also allows the designer to place the device closer to the signal source to reduce noise pickup and increase signal integrity.

AZV321 is also available in standard SOT-23-5 package.

Features

(For $V_{CC}=5V$ and $V_{EE}=0V$, Typical unless Otherwise Noted)

- Guaranteed 2.7V to 5.5V Performance.
- No Crossover Distortion
- Gain-Bandwidth Product 1MHz
- Industrial Temperature Range: $-40^{\circ}C$ to $+85^{\circ}C$
- Low Supply Current: 130 μ A
- Rail-to-Rail Output Swing under 10k Ω Load:
 - V_{OH} up to $V_{CC} - 10mV$
 - V_{OL} near to $V_{EE} + 65mV$
- V_{CM} : $-0.2V$ to $V_{CC} - 0.8V$

Applications

- Active Filters
- Low Power, Low Voltage Applications
- General Purpose Portable Devices
- Cellular Phone, Cordless Phone
- Battery-Powered Systems

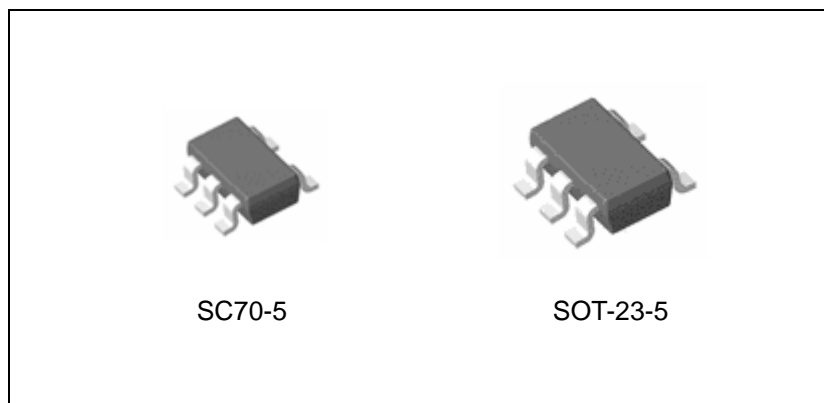

Figure 1. Package Types of AZV321



SINGLE LOW VOLTAGE RAIL-TO-RAIL OUTPUT OPERATIONAL AMPLIFIER **AZV321**

Pin Configuration

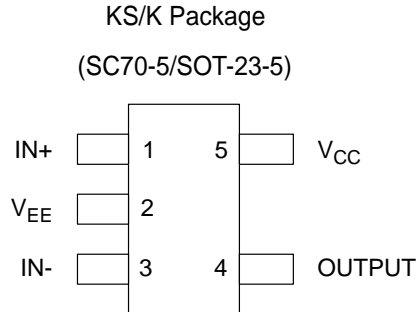

Figure 2. Pin Configuration of AZV321 (Top View)

Functional Block Diagram

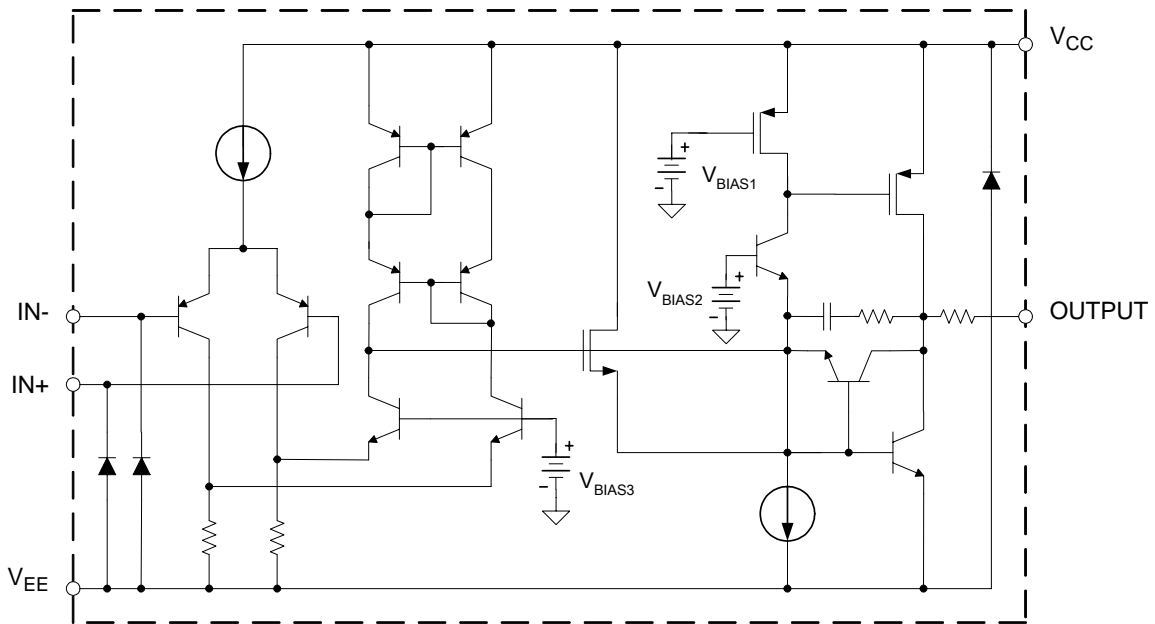
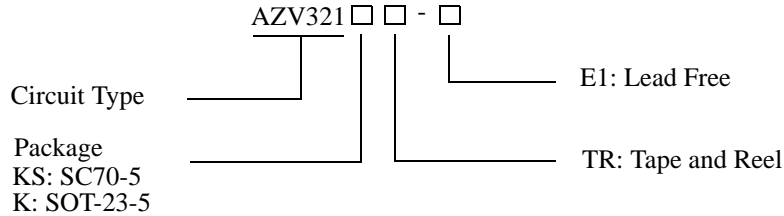

Figure 3. Functional Block Diagram of AZV321



SINGLE LOW VOLTAGE RAIL-TO-RAIL OUTPUT OPERATIONAL AMPLIFIER AZV321

Ordering Information



Package	Temperature Range	Part Number	Marking ID	Packing Type
		Lead Free	Lead Free	
SC70-5	-40 to 85°C	AZV321KSTR-E1	21	Tape & Reel
SOT-23-5	-40 to 85°C	AZV321KTR-E1	E6T	Tape & Reel

BCD Semiconductor's Pb-free products, as designated with "E1" suffix in the part number, are RoHS compliant.

Absolute Maximum Ratings (Note 1)

Parameter	Symbol	Value	Unit
Power Supply Voltage	V_{CC}	6	V
Operation Junction Temperature	T_J	150	°C
Storage Temperature Range	T_{STG}	-65 to 150	°C
Lead Temperature (Soldering, 10 Seconds)	T_{LEAD}	260	°C
ESD (Machine Model)		200	V
ESD (Human Body Model)		2000	V

Note 1: Stresses greater than those listed under "Absolute Maximum Ratings" may cause permanent damage to the device. These are stress ratings only, and functional operation of the device at these or any other conditions beyond those indicated under "Recommended Operating Conditions" is not implied. Exposure to "Absolute Maximum Ratings" for extended periods may affect device reliability.

Recommended Operating Conditions

Parameter	Symbol	Min	Max	Unit
Supply Voltage	V_{CC}	2.7	5.5	V
Ambient Operating Temperature Range	T_A	-40	85	°C



SINGLE LOW VOLTAGE RAIL-TO-RAIL OUTPUT OPERATIONAL AMPLIFIER AZV321

2.7V Electrical Characteristics

All limits are guaranteed for $T_A=25^{\circ}\text{C}$, $V_{CC}=2.7\text{V}$, $V_{EE}=0\text{V}$, $V_{CM}=1.0\text{V}$, $V_O=V_{CC}/2$ and $R_L>1\text{M}\Omega$, limits in **bold types** are guaranteed for $T_A=-40$ to 85°C , unless otherwise specified. (Note 2)

Parameter	Symbol	Conditions	Min	Typ	Max	Unit
Input Offset Voltage	V_{IO}			1.7	7	mV
					9	
Input Bias Current	I_B			11	250	nA
					500	
Input Offset Current	I_{IO}			5	50	nA
					150	
Input Common Mode Voltage Range	V_{CM}	for $\text{CMRR}\geq 50\text{dB}$	-0.2		1.9	V
Supply Current	I_{CC}	$V_O=V_{CC}/2$, $A_{VCL}=1$, no load		80	170	μA
					270	
Common Mode Rejection Ratio	CMRR	$0\leq V_{CM}\leq 1.7\text{V}$	50	65		dB
Power Supply Rejection Ratio	PSRR	$2.7\text{V}\leq V_{CC}\leq 5\text{V}$, $V_O=1\text{V}$,	50	60		dB
Output Short Circuit Current	I_{SOURCE}	$V_O=0\text{V}$	5	20		mA
	I_{SINK}	$V_O=2.7\text{V}$	10	30		mA
Output Voltage Swing	V_{OH}	$R_L=10\text{k}\Omega$ to 1.35V	2.60	2.69		V
	V_{OL}			60	180	mV
Gain Bandwidth Product	GBWP	$C_L=200\text{pF}$		1		MHz
Phase Margin	ϕ_M			60		Deg
Gain Margin	G_M			10		dB

Note 2: Limits over the full temperature are guaranteed by design, but not tested in production.



SINGLE LOW VOLTAGE RAIL-TO-RAIL OUTPUT OPERATIONAL AMPLIFIER AZV321

5V Electrical Characteristics

All limits are guaranteed for $T_A=25^{\circ}\text{C}$, $V_{CC}=5\text{V}$, $V_{EE}=0\text{V}$, $V_{CM}=2.0\text{V}$, $V_O=V_{CC}/2$ and $R_L>1\text{M}\Omega$, limits in **bold types** are guaranteed for $T_A=-40$ to 85°C , unless otherwise specified. (Note 2)

Parameter	Symbol	Conditions	Min	Typ	Max	Unit
Input Offset Voltage	V_{IO}			1.7	7	mV
					9	
Input Bias Current	I_B			11	250	nA
					500	
Input Offset Current	I_{IO}			5	50	nA
					150	
Input Common Mode Voltage Range	V_{CM}	for $\text{CMRR}\geq 50\text{dB}$	-0.2		4.2	V
Supply Current	I_{CC}	$V_O=V_{CC}/2$, $A_{VCL}=1$, no load		130	250	μA
					350	
Large Signal Voltage Gain	G_V	$R_L=2\text{k}\Omega$	84	100		dB
			80			
Common Mode Rejection Ratio	CMRR	$0\leq V_{CM}\leq 4\text{V}$	50	65		dB
Power Supply Rejection Ratio	PSRR	$2.7\text{V}\leq V_{CC}\leq 5\text{V}$ $V_O=1\text{V}$, $V_{CM}=1\text{V}$	50	60		dB
Output Short Circuit Current	I_{SOURCE}	$V_O=0\text{V}$	5	60		mA
	I_{SINK}	$V_O=5\text{V}$	10	160		mA
Output Voltage Swing	V_{OH}	$R_L=2\text{k}\Omega$ to 2.5V	4.7	4.96		V
			4.6			
		$R_L=10\text{k}\Omega$ to 2.5V	4.9	4.99		
			4.8			
	V_{OL}	$R_L=2\text{k}\Omega$ to 2.5V		120	300	mV
					400	
$R_L=10\text{k}\Omega$ to 2.5V			65	180		
				280		
Slew Rate	SR		1		V/ μS	
Gain Bandwidth Product	GBWP	$C_L=200\text{pF}$		1		MHz
Phase Margin	ϕ_M			60		Deg
Gain Margin	G_M			10		dB

Note 2: Limits over the full temperature are guaranteed by design, but not tested in production.



SINGLE LOW VOLTAGE RAIL-TO-RAIL OUTPUT OPERATIONAL AMPLIFIER AZV321

Typical Performance Characteristics

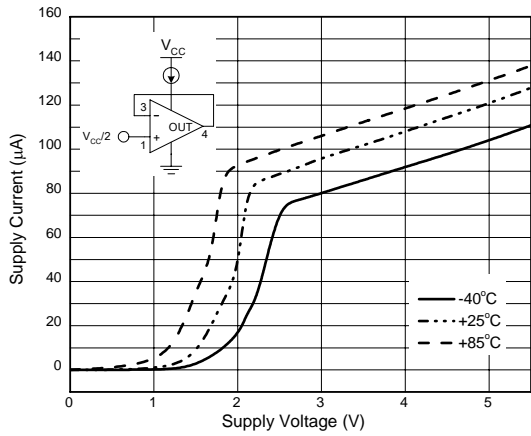

Figure 4. Supply Current vs. Supply Voltage

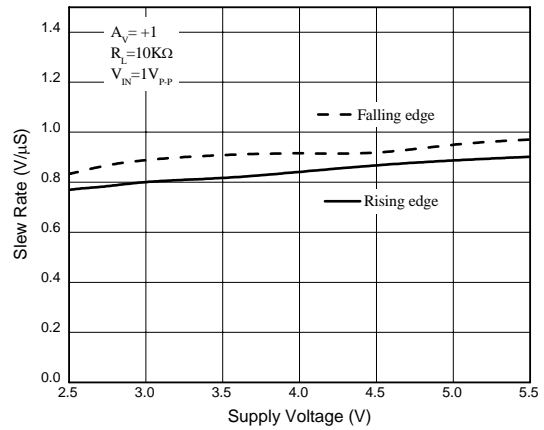

Figure 5. Slew Rate vs. Supply Voltage

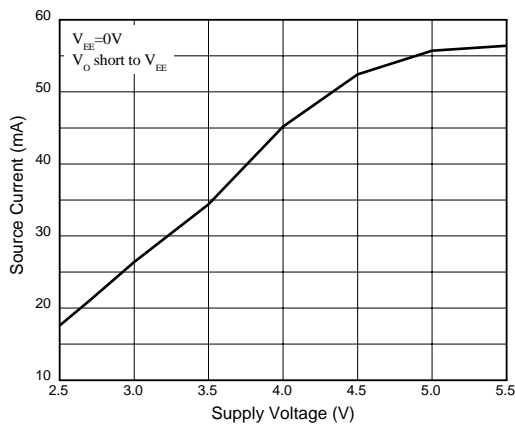

Figure 6. Output Source Current vs. Supply voltage

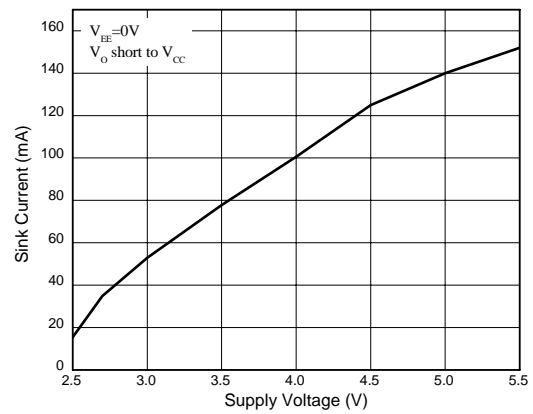

Figure 7. Output Sink Current vs. Supply Voltage



SINGLE LOW VOLTAGE RAIL-TO-RAIL OUTPUT OPERATIONAL AMPLIFIER AZV321

Typical Performance Characteristics (Continued)

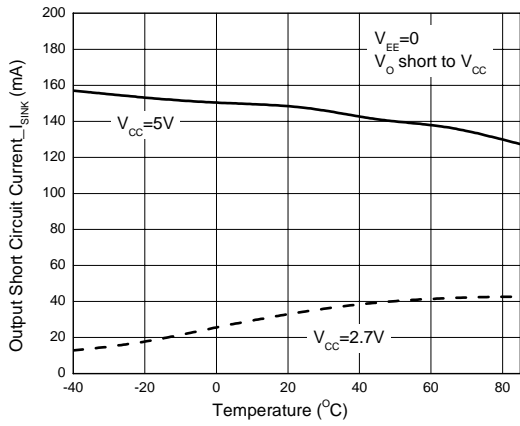

Figure 8. Short Circuit Current I_{SINK} vs. Temperature

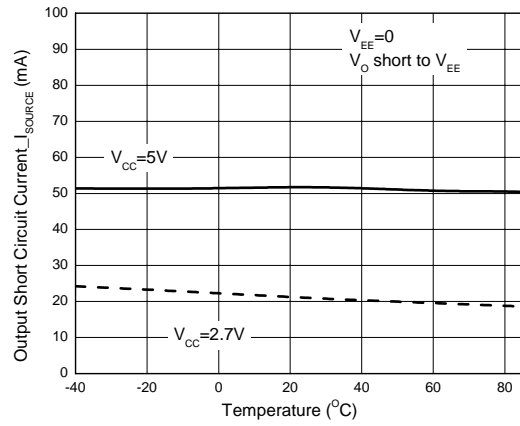

Figure 9. Short Circuit Current I_{SOURCE} vs. Temperature

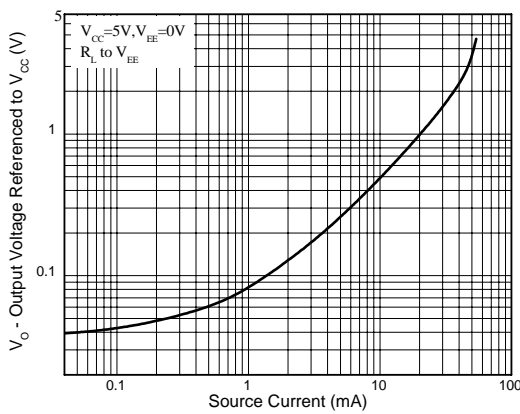

Figure 10. Output Voltage vs. Source Current

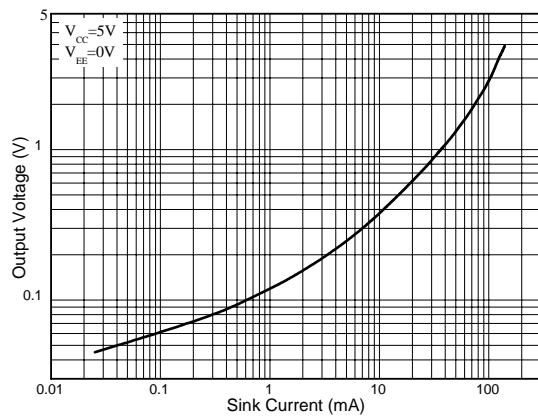

Figure 11. Output Voltage vs. Sink Current



SINGLE LOW VOLTAGE RAIL-TO-RAIL OUTPUT OPERATIONAL AMPLIFIER AZV321

Typical Performance Characteristics (Continued)

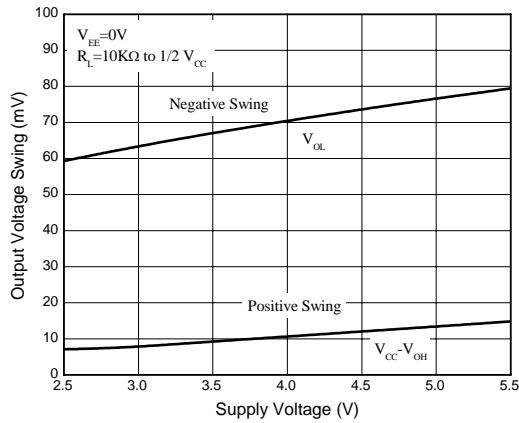

Figure 12. Output Voltage Swing vs. Supply Voltage

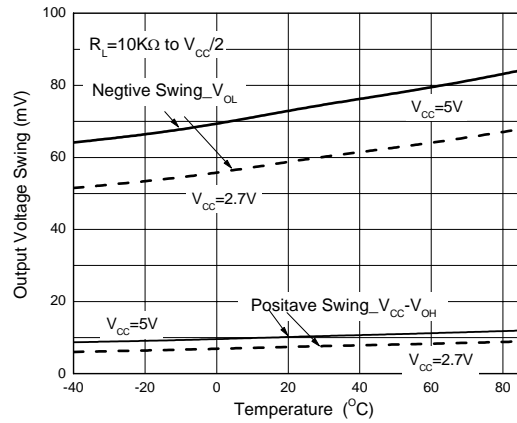

Figure 13. Output Voltage Swing vs. Temperature

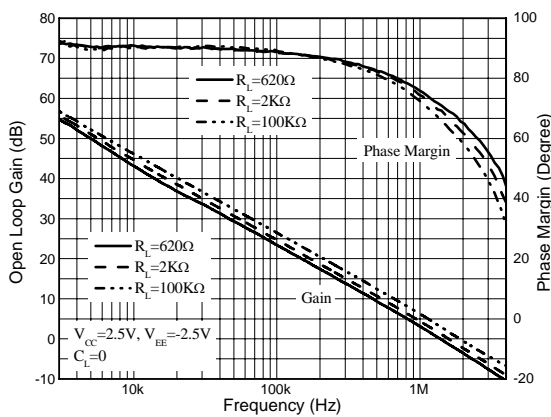

Figure 14. Gain and Phase vs. Frequency and Resistive Load



SINGLE LOW VOLTAGE RAIL-TO-RAIL OUTPUT OPERATIONAL AMPLIFIER AZV321

Typical Performance Characteristics (Continued)

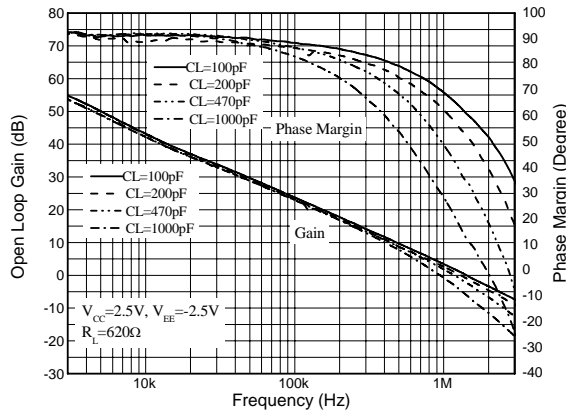

Figure 15. Gain and Phase vs. Frequency and Capacitive Load

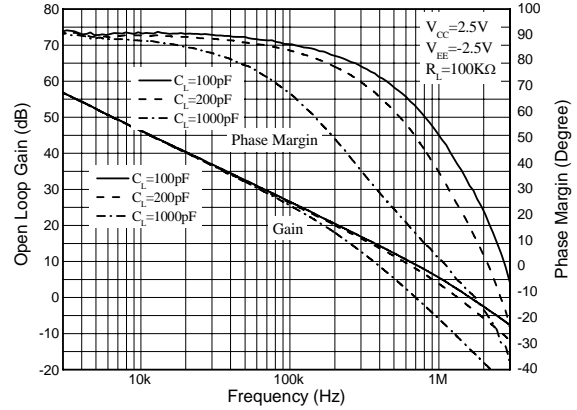

Figure 16. Gain and Phase vs. Frequency and Capacitive Load

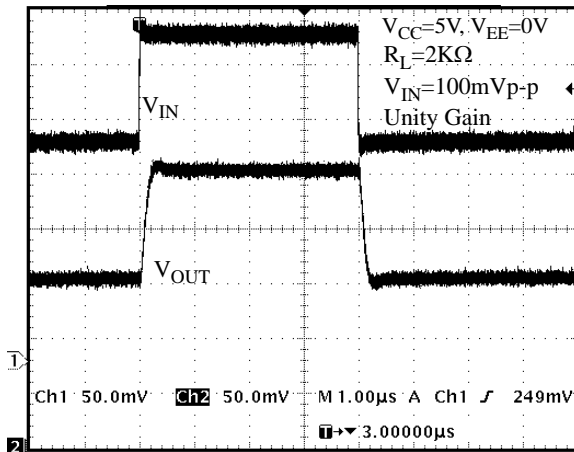

Figure 17. Non-Inverting Input Small Signal Pulse Response

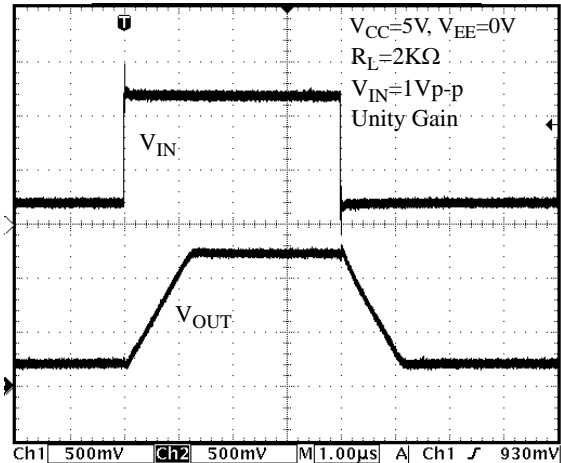

Figure 18. Non-Inverting Input Large Signal Pulse Response



SINGLE LOW VOLTAGE RAIL-TO-RAIL OUTPUT OPERATIONAL AMPLIFIER AZV321

Typical Performance Characteristics (Continued)

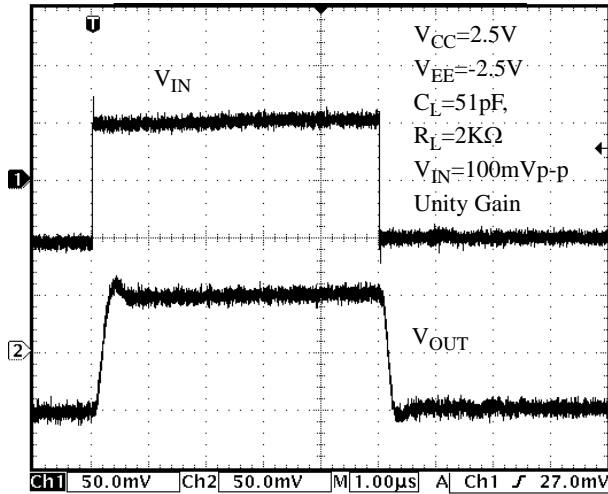

Figure 19. Output with Excessive Capacitive Load

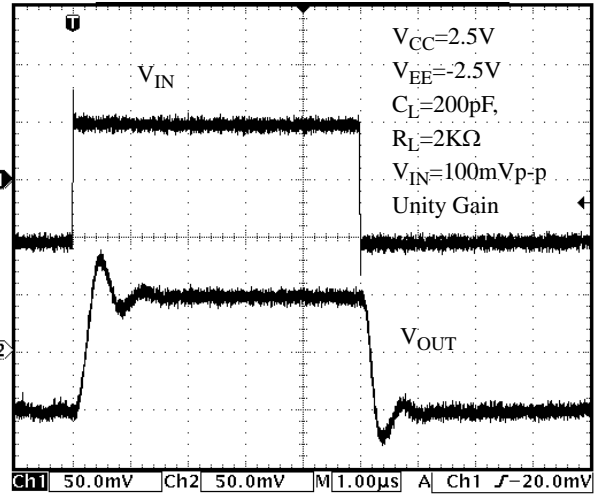

Figure 20. Output with Excessive Capacitive Load

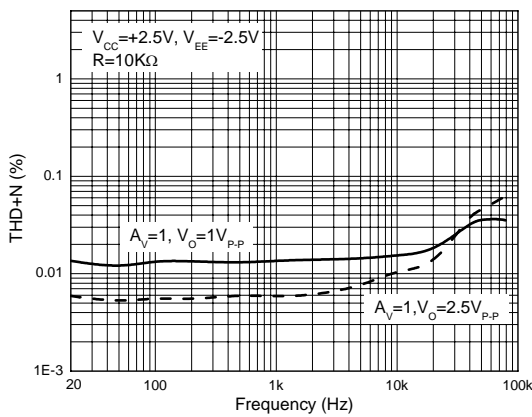

Figure 21. THD+N vs. Frequency



SINGLE LOW VOLTAGE RAIL-TO-RAIL OUTPUT OPERATIONAL AMPLIFIER **AZV321**

Mechanical Dimensions

SC70-5

Unit: mm(inch)

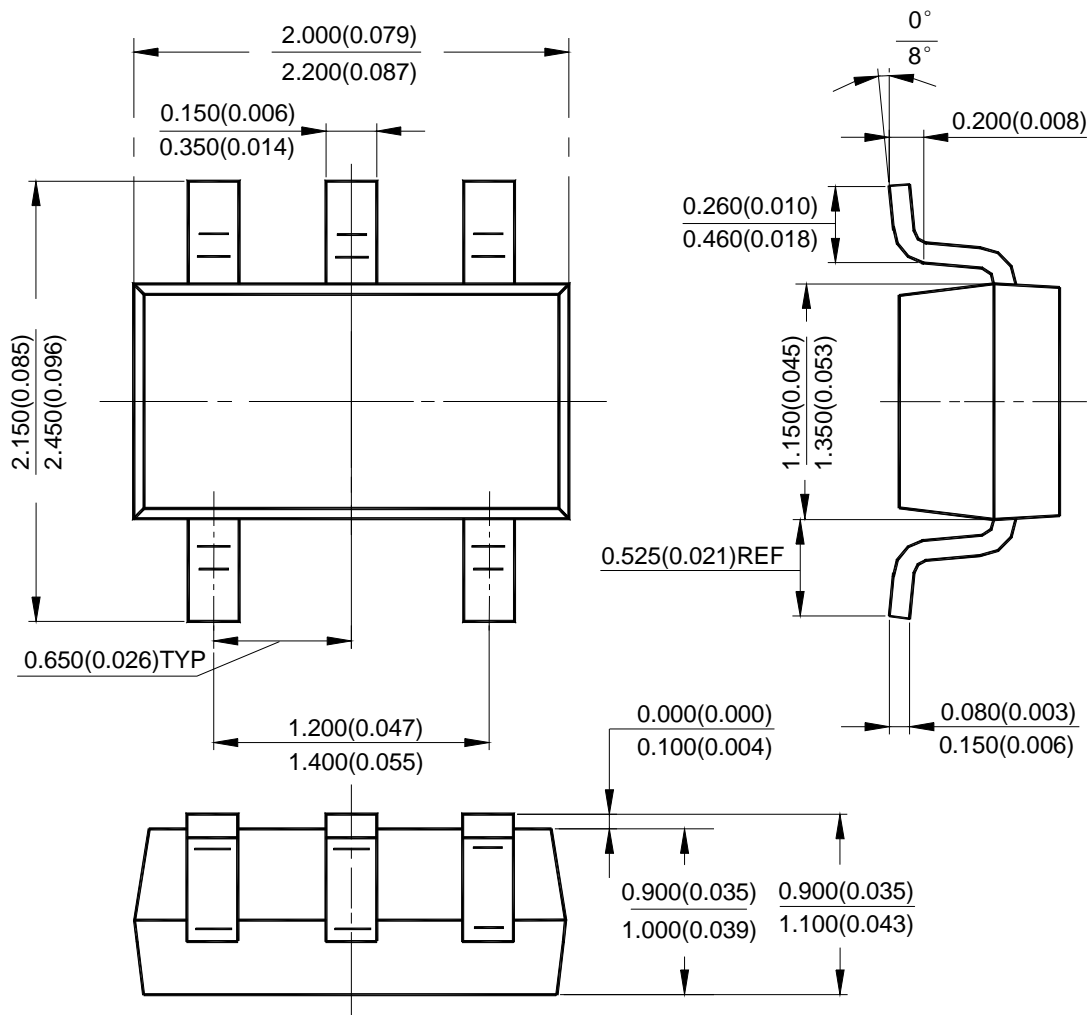



SINGLE LOW VOLTAGE RAIL-TO-RAIL OUTPUT OPERATIONAL AMPLIFIER AZV321

Mechanical Dimensions

SOT-23-5

Unit: mm(inch)

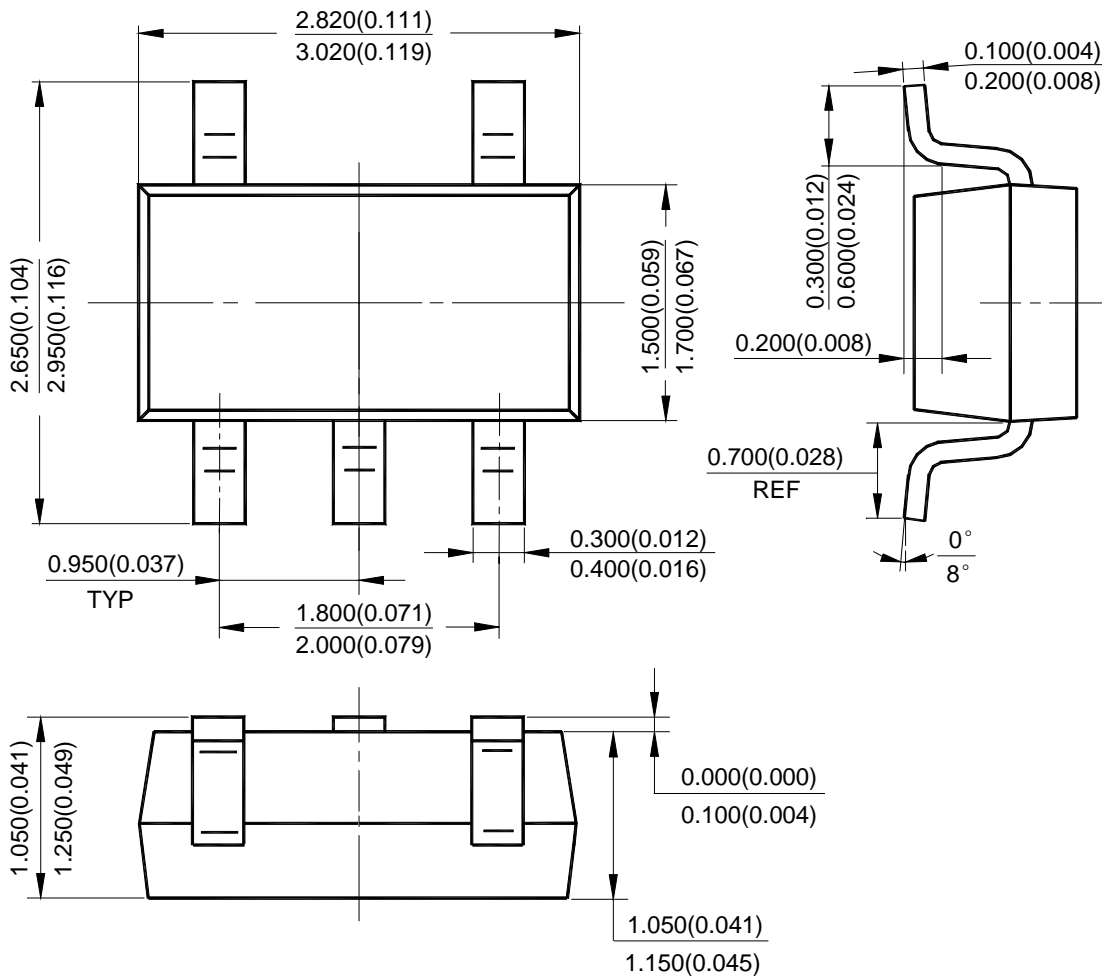



BCD Semiconductor Manufacturing Limited

<http://www.bcdsemi.com>

IMPORTANT NOTICE

BCD Semiconductor Manufacturing Limited reserves the right to make changes without further notice to any products or specifications herein. BCD Semiconductor Manufacturing Limited does not assume any responsibility for use of any its products for any particular purpose, nor does BCD Semiconductor Manufacturing Limited assume any liability arising out of the application or use of any its products or circuits. BCD Semiconductor Manufacturing Limited does not convey any license under its patent rights or other rights nor the rights of others.

MAIN SITE

BCD Semiconductor Manufacturing Limited

- Wafer Fab

Shanghai SIM-BCD Semiconductor Manufacturing Limited

800, Yi Shan Road, Shanghai 200233, China
Tel: +86-21-6485 1491, Fax: +86-21-5450 0008

BCD Semiconductor Manufacturing Limited

- IC Design Group

Advanced Analog Circuits (Shanghai) Corporation

8F Zone B, 900, Yi Shan Road, Shanghai 200233, China
Tel: +86-21-6495 9539, Fax: +86-21-6485 9673

REGIONAL SALES OFFICE

Shenzhen Office

Shanghai SIM-BCD Semiconductor Manufacturing Co., Ltd. Shenzhen Office

Advanced Analog Circuits (Shanghai) Corporation Shenzhen Office
Room E, 5F, Noble Center, No.1006, 3rd Fuzhong Road, Futian District, Shenzhen 518026, China
Tel: +86-755-8826 7951
Fax: +86-755-8826 7865

Taiwan Office

BCD Semiconductor (Taiwan) Company Limited

4F, 298-1, Rui Guang Road, Nei-Hu District, Taipei, Taiwan
Tel: +886-2-2656 2808
Fax: +886-2-2656 2806

USA Office

BCD Semiconductor Corporation

30920 Huntwood Ave. Hayward, CA 94544, U.S.A
Tel: +1-510-324-2988
Fax: +1-510-324-2788